

USER MANUAL

AVL DITEST MULTISENSE MS 1000



ID number: AT7820E
Revision: 01
Edition: 03/2018
Software version:

Data subject to change and errors excepted.
All data valid at the time of print.

FUTURE SOLUTIONS FOR TODAY

AVL DiTEST GmbH
Alte Poststrasse 156
8020 Graz
AUSTRIA
Phone: +43 316 787-0
Fax: +43 316 787-1460
ditest@avl.com
www.avlditest.com

Copyright © 2018 AVL DiTEST GmbH, all rights reserved.

The content of this publication may not be reproduced in any way or forwarded to third parties, either in part or in full, without the prior written consent of AVL DiTEST. This publication was created with due care such that AVL DiTEST is not liable for any remaining errors or omissions or for any damages arising therefrom.

Warning and safety instructions

This user manual contains important **warning and safety instructions** that must be observed by the user.

The product is intended only for the highly specific use described in the user manual. The most important prerequisites and safety measures for the use and operation of the product are also described to ensure faultless operation.

No warranty can be given and no liability is assumed for applications exceeding the described intended use, irrespective of observance of the necessary prerequisites and safety measures.

The product must only be used and operated by personnel who, based on their qualifications, are capable of adhering to the necessary safety measures during use and operation. Only accessories and consumables supplied by AVL DiTEST or approved by AVL DiTEST must be used. The measurement results obtained from the product in question depend not only on the correct functioning of the product, but also on a series of general conditions. The results delivered by the product must, therefore, be evaluated by a specialist (e.g. plausibility check) before further action is taken on the basis of a delivered measurement.

Adjustment and maintenance works on open live devices may only be performed by trained specialists who are aware of the associated danger.

The product may only be repaired in the factory of origin or by specialists specifically trained to perform such repair.

When using the product, it must be ensured by a specialist that the test object or test system is not brought into any operational state that could result in damage to goods or endangerment of people.

SAFETY INSTRUCTIONS

**WARNING**

Read all instructions carefully!

**DANGER**

Danger of death due to electrical voltage on vehicles with high-voltage systems

Deadly high voltages are present on the HV energy store (HV battery) and on parts connected to it!

Make sure no-one can come into contact with the connections on the HV battery, connecting cables of the HV battery or other parts under high voltage!

**WARNING**

Danger to life by electric potential on the ignition system

The ignition system carries a deadly high voltage!

Do not touch the ignition system while the motor is running!

**WARNING**

Danger to life by electric potential on vehicles with Xenon light

A lighting system that uses a xenon light carries a deadly high voltage!

Do not touch the components of the xenon light while the lighting is turned on!

**WARNING**

Danger from harmful or irritating substances

When performing measurements on the running motor in closed rooms (workshops, test halls, etc.), extract the vehicle exhaust gases and ventilate the rooms thoroughly!

**WARNING****Danger of burns from hot parts**

Measurements must be performed at normal motor operating temperature or in accordance with the test specification! Do not touch hot parts such as the motor, motor components or any of the entire exhaust system! Use cooling fans if necessary!

**WARNING****Danger of injury due to rotating parts**

Wherever possible, any work in the engine compartment should be performed while the engine and ignition are off!
Do not touch any rotating parts such as alternator, radiator fan or their drives (e.g. drive belts)!

**WARNING****Risk of explosions due to pyrotechnical setups and restraint systems**

- Testing and assembly work may only be performed by trained personnel!
 - Never test the igniter with a multimeter!
 - Only perform system tests with approved testing equipment!
 - Disconnect the battery when working on the airbag system!
 - When reconnecting the battery, the ignition must be turned off and there must be no person inside the vehicle.
 - Always store the airbag unit with the discharge side facing upwards or according to the storage specifications!
 - Never leave the airbag unit lying around unattended!
 - Protect the airbag unit against flying sparks, open fire and temperatures above 100°C (212°F)!
 - Do not transport the airbag unit in the passenger space!
 - Do not allow the airbag unit to come into contact with oil, grease or cleaning agents!
 - An airbag unit that has been dropped from a height greater than 0.5 m (19.7 in.) must be renewed!
 - Dispose of untriggered airbag units!
 - Do not open or repair the airbag unit!
-

**WARNING****Risk of explosion or fire due to gases and/or vapors**

Do not operate the device in the vicinity of open fuel tanks or below a minimum height of 460 mm above the workshop floor because, otherwise, there is a risk of explosion or fire due to gases and/or vapors.

**WARNING****Risk due to improper use**

Only use the device as described in the manual.

When the device is used in a way it is not intended for, the protection provided by the device may be impaired.

Use only the devices and components recommended by the manufacturer.

**WARNING****Risk due to improper use**

Device without rated overvoltage category - limits 500 V DC and 250 V AC.

The device must not be used in the measurement categories II, III and IV.

**WARNING****Risk due to improper repair**

Unauthorized opening or improper repair of the device can cause considerable risks.

**WARNING****Risk due to radio wave radiation**

FCC and FAA regulations prohibit the use of wireless HF devices in the air because their signals can interfere with important instruments aboard aircrafts.

**CAUTION**

Make sure measurement cables are laid safely while the motor is running!

The cables must not hang over the edges of tables, benches or desks.

They must not get in touch with hot manifolds or rotating fan blades.

**CAUTION**

The use of extension cables is prohibited.

Use only required cables.

KEEP THESE INSTRUCTIONS!

Contents

Warning and safety instructions I

SAFETY INSTRUCTIONS..... III

1 General 1-1

 1.1 General Description 1-1

 1.2 Top view 1-2

 1.3 Side view..... 1-3

 1.4 Frontal view..... 1-3

2 Start-up..... 2-1

3 Measuring With AVL DiTEST MS 1000 3-1

4 Maintenance and Care..... 4-1

5 Faults and Clearance 5-1

6 Technical Data 6-1

 6.1 General Specifications 6-1

 6.1.1 Power Supply 6-1

 6.1.2 Physical/Environmental Characteristics 6-1

 6.1.3 CE & UL Certification..... 6-1

 6.2 Probes and Adapters 6-2

 6.2.1 Optical Tachometer 6-2

 6.2.2 Magnetic Tachometer..... 6-2

 6.2.3 Stroboscope 6-2

 6.2.4 Acoustic Sound Transducer 6-3

 6.2.5 Contact Mechanical Vibration Sensor 6-3

 6.2.6 Luxmeter..... 6-3

 6.3 Disposal 6-4

1 General

1.1 General Description

AVL DiTEST MULTISENSE 1000 (MS 1000) is an accessory for the **AVL DiTEST SCOPE 1200/1400**.

The AVL MS 1000 is:

- an ignition timing stroboscope for the timing of ignition points
- an LED flashlight with dimming function
- a dynamic luxmeter to measure luminous intensity and sensitivity
- an optical light reflex sensor, e.g. for speed recognition or motion detection.
- a dynamic microphone to detect an analogue acoustic signal for signal analysis and relative noise measurement
- a stethoscope to display relative hardware-based (mechanical) vibration
- a magnetic field detector to record signals from installed magnetic sensors, for instance to define the magnetic sensor side in the case of wheel bearings. (in removed state)

The MS 1000 offers practical handling, intuitive operation and multiple mounting options. Its functionality is strengthened by haptic and acoustic feedback from certain signals and set-up operations.

Communication and data provision are realized with the measuring device AVL DiTEST SCOPE 1200/1400

Always use this user manual together with the user manuals:

- AVL DiTEST SCOPE 1200/1400
- AVL DiTEST DSS

1.2 Top view

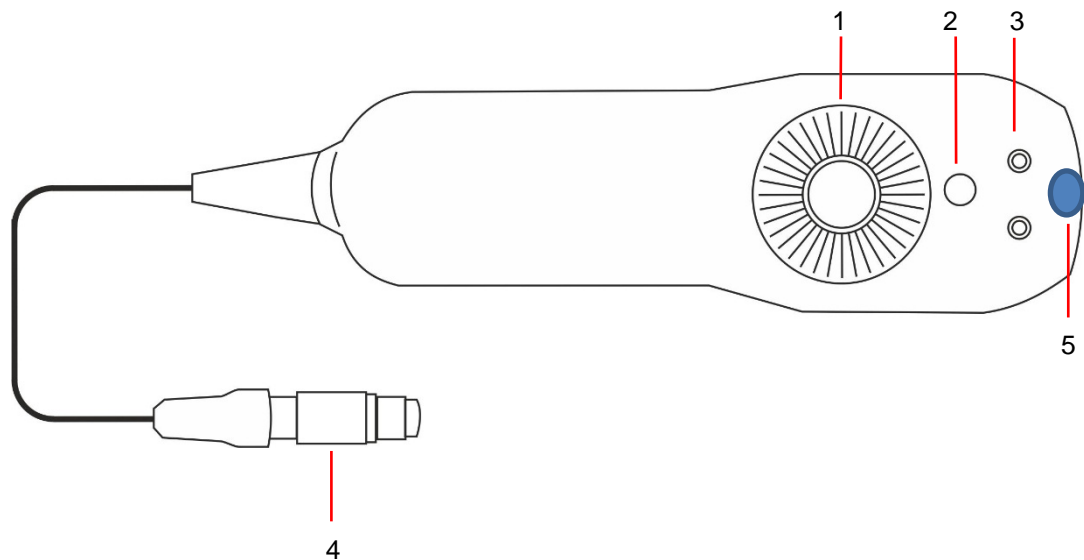

Fig. 1-1

- | | | |
|-----|---------------------------------|--|
| (1) | Setting dial | for setting parameters, e.g.: angular degree adjustment on the stroboscope and brightness control in the flashlight mode |
| (2) | Push button | switch to the "flashlight" mode
keeping pressed for extended period of time:
Light source is activated
After letting go, the previous state is restored
one-time activation: Light source is activated and remains activated
pressing again restores the previous state |
| (3) | LEDs | LED blue: operational readiness
LED green: status display |
| (4) | Cable with plug | for connection to AVL DiTEST SCOPE 1200/1400 |
| (5) | Magnetic field sensitive sensor | |

1.3 Side view

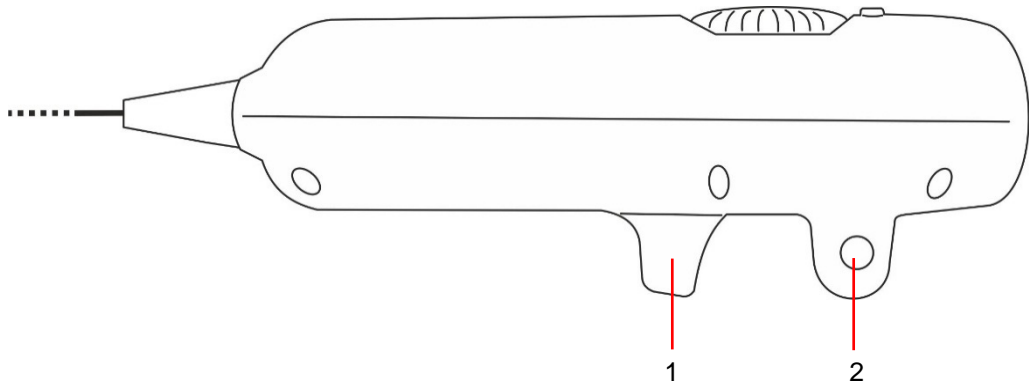

Fig. 1-2

- | | | |
|-----|-------------|--|
| (1) | Push button | Function depending on the current mode of operation (stroboscope flashlight release) |
| (2) | Holes | for the various fixing options for the AVL DiTEST MS 1000 by means of commercially available fixing devices from the photo and camera sector |

1.4 Frontal view

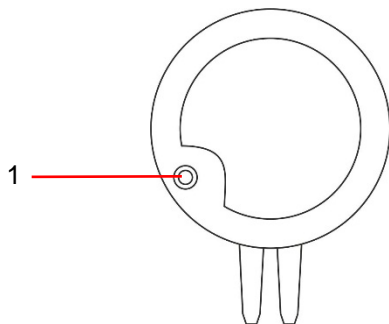

Fig. 1-3

- | | | |
|-----|-----------------------|--|
| (1) | Microphone and thread | for acoustic signal pick-up
for screwing in the stethoscope rod |
|-----|-----------------------|--|

2 Start-up

AVL DiTEST SCOPE 1400/1200

Basically you can connect the AVL DiTEST MS 1000 to all 4 channels (Scope 1200: 2).

For the functions "Stroboscope" and "Ignition angle", you have to connect AVL DiTEST MS 1000 to CH1. In addition, you need a trigger signal on CH2.

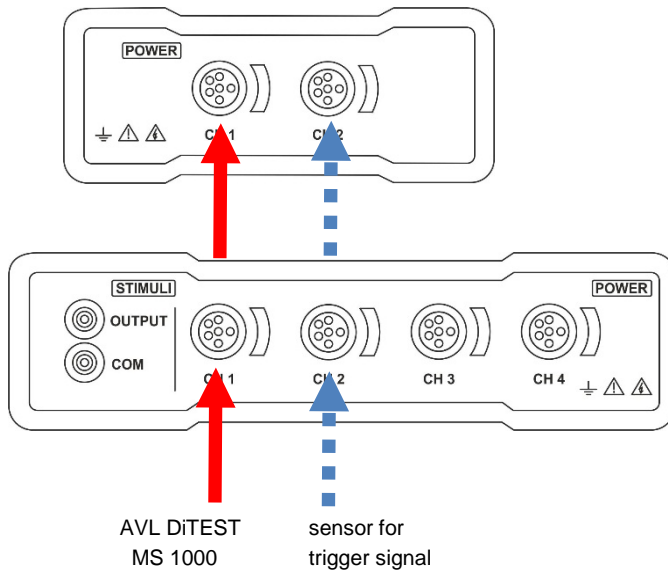

Fig. 2-1

3 Measuring With AVL DiTEST MS 1000

Start the AVL DiTEST MS 1000.

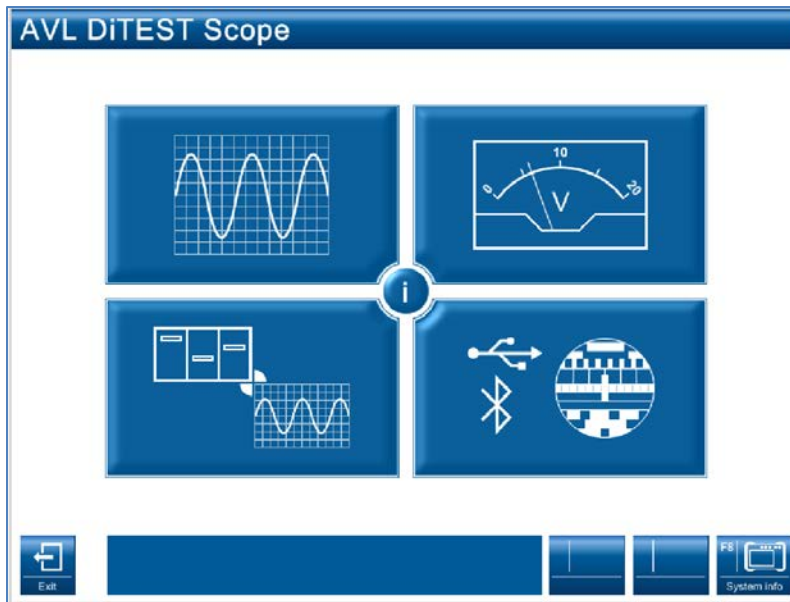



Fig. 3-1

Tap  (universal oscilloscope).

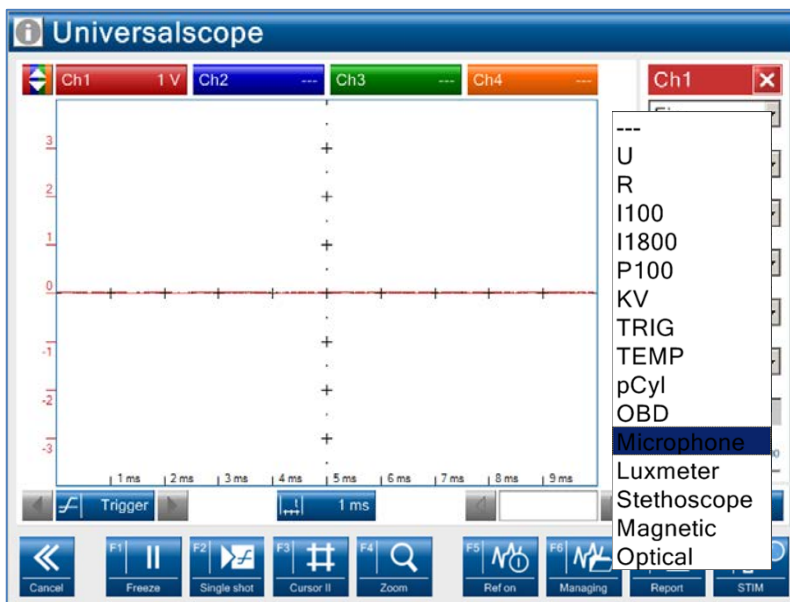

Fig. 3-2

In the pop-up menu "Sensor", select the respective sensor (in the example: microphone).

The test result is displayed.

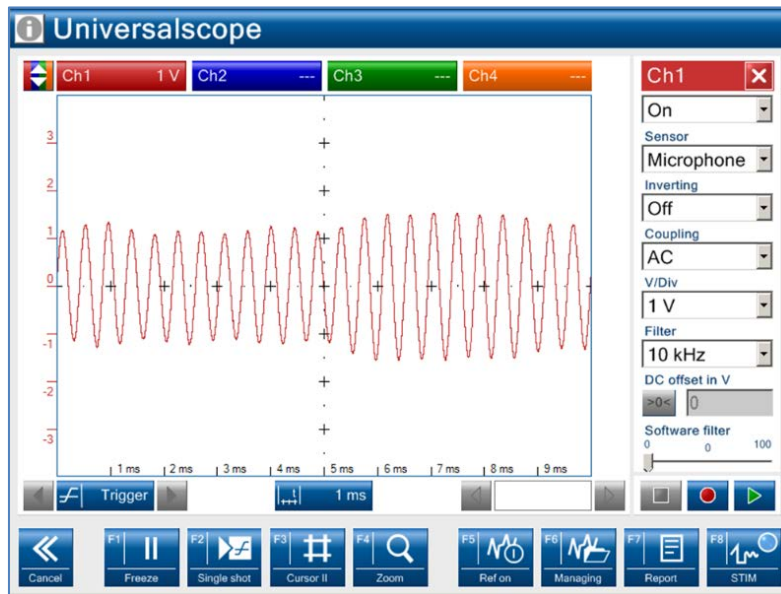

Fig. 3-3

Here, the acoustic signals from the microphone are graphically represented. For the various adjustment options, please refer to the user manual AVL DiTEST SCOPE 1200/1400.

In the pop-up menu "Sensor", you can currently also select the sensors: luxmeter, stethoscopes, magnetic and optical.

Luxmeter:

Here, the signals of an optical sensor are graphically represented.

Stethoscopes:

By means of a screw-in stethoscope rod (see chapter 1-4 front view), the structure-borne noise signals, e.g. of a fuel injector housing during targeting with the stethoscope rod, are graphically represented by means of the microphone installed in the AVL DiTEST MS 1000.

Magnetic:

Here, the signals of a magnetic field sensor (see chapter 1-2 top view) are graphically represented.

Optical:

The sensor emits a light ray which can be directed to a point. (e. g.: to a reflector tag). A stick-on reflector tag (not included in the scope of delivery) shows reflector pulses and so, for example: speed can be measured.

NOTE

The acquisition of all signals is only relative and they do not represent absolute values!

Stroboscope and ignition angle

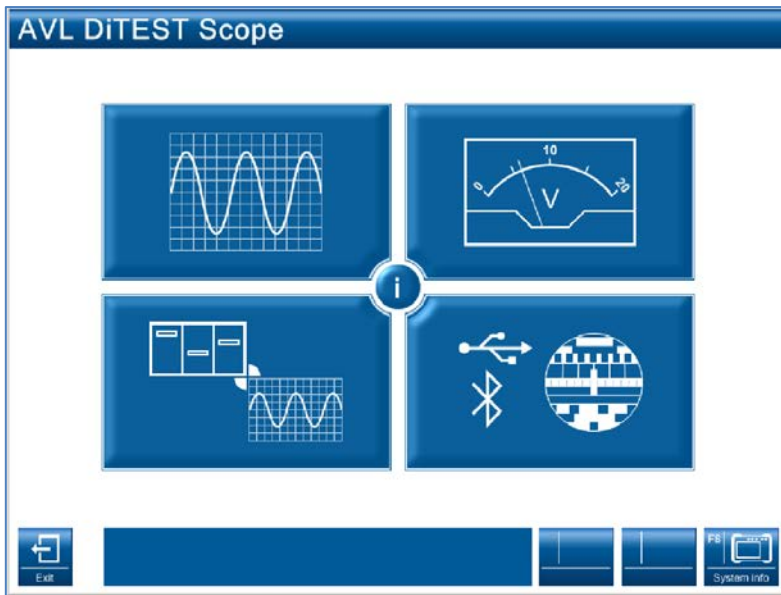

Fig. 3-4

In the main menu, tap  (special measurements).

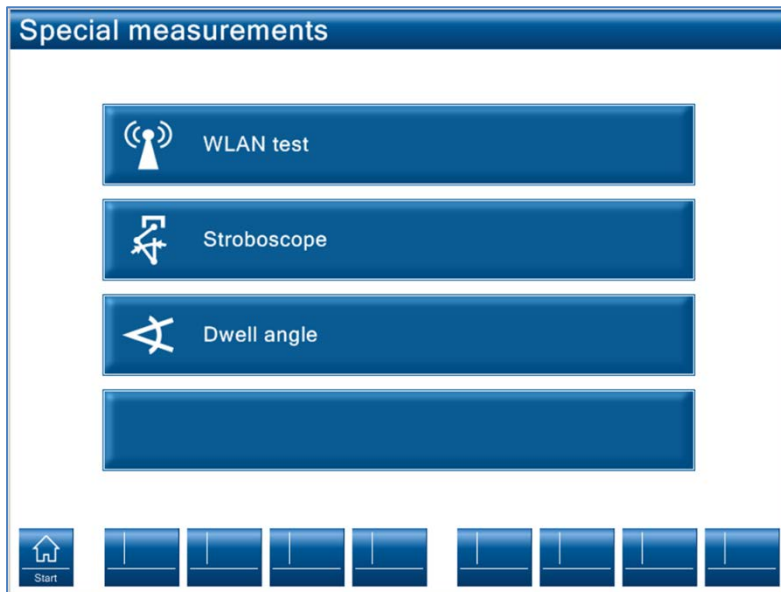

Fig. 3-5

Select stroboscope or ignition angle.

A screen with connection information opens.

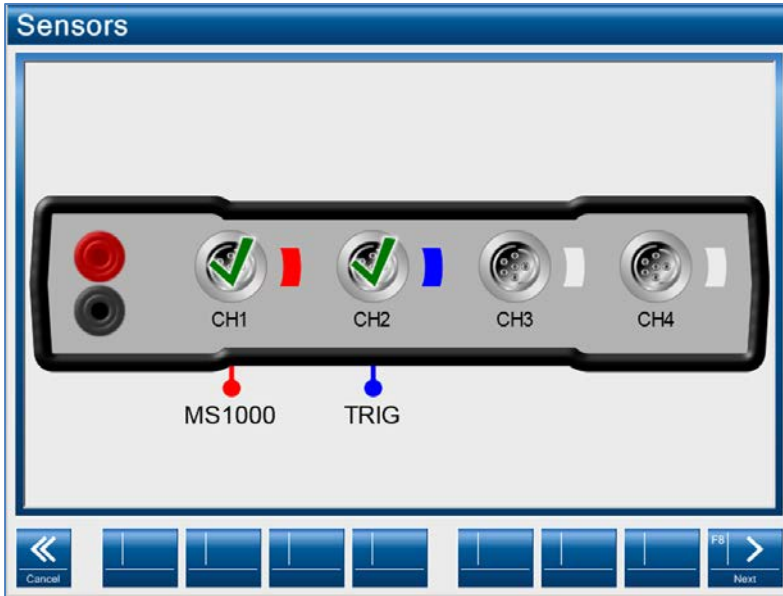

Fig. 3-6

The test result is displayed.

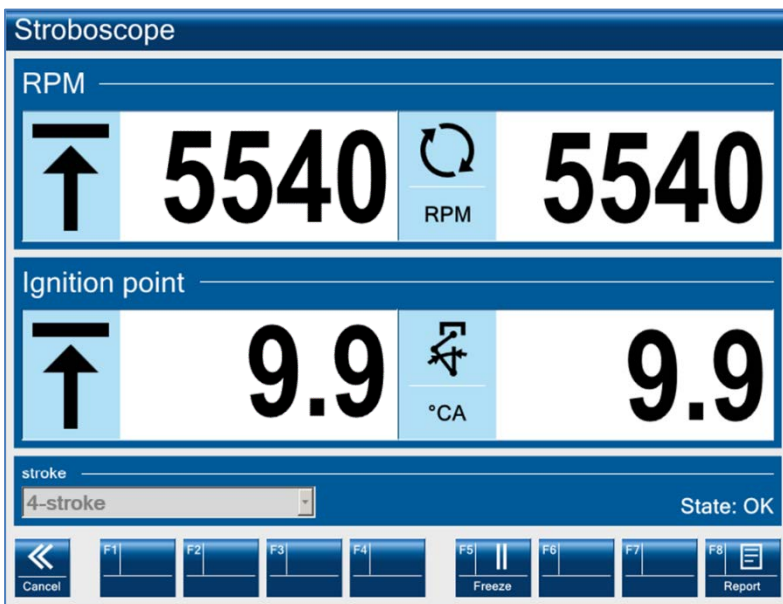

Fig. 3-7

4 Maintenance and Care

As to that, take notice of:

- User manual AVL DiTEST SCOPE 1400/1200, chap. 4 "*Maintenance and Care*".

5 **Faults and Clearance**

As to that, take notice of:

- User manual AVL DiTEST SCOPE 1400/1200, chap. 5 "*Faults and Clearance*".

6 Technical Data

6.1 General Specifications

6.1.1 Power Supply

Parameters	Specification
Power supply	Via AVL Scope 1200/1400
Max. power input	2.4 watt

6.1.2 Physical/Environmental Characteristics

Parameters	Specification
Dimensions	
Housing	
Weight	
Operating temperature range	0 °C to +50 °C
Air humidity	30 % to 95 %
Operational altitude	max. 3048 m above mean sea level
Storage temperature	-20 °C to +60 °C

6.1.3 CE & UL Certification

Parameters	Specification
CE conformity	2004/108/EC EMV Directive 2006/95/EC Low Voltage Directive 1999/5/EC RTTE Directive EN 61326-1:2006 EN 55022:2010 EN 61010-1:2010 EN 61010-2-030:2010
UL certification	UL-201 garage equipment

6.2 Probes and Adapters

6.2.1 Optical Tachometer

Parameters	Specification

6.2.2 Magnetic Tachometer

Parameters	Specification

6.2.3 Stroboscope

Parameters	Specification

6.2.4 Acoustic Sound Transducer

Parameters	Specification

6.2.5 Contact Mechanical Vibration Sensor

Parameters	Specification

6.2.6 Luxmeter

Parameters	Specification
Kilolux [klx]	0-130 klx
Frequency	

6.3 Disposal



This high-quality electrical and electronic equipment must not be disposed of with domestic waste.

For disposal, it is essential to comply with local legal obligations!

CE Conformity

